

Technical Information — Sizes

End Cap (Square Nose)

End Caps are used to transition from laminate to carpet, masonry (fireplaces), sliding doors and other exterior door jambs. **Available as Standard or Moisture Resistant.**

Surface Material: High Wear Resistant Aluminum Oxide Laminate

Core Material:

Standard End Cap: Moisture Resistant MDF

Moisture Resistant End Cap: Exterior Grade Composite Wood Product

Versatrack Shim

To be used with T-Molding, Reducer and End Cap in conjunction with the Versatrack (metal) for floors from 9.5mm-12.3mm thickness including 3/32nd underlayment.

Material: Standard HDF

Versatrack

To be used with T-Molding, Reducer and End Cap for floors from 6mm-9.5mm thickness including 3/32nd underlayment. Also, used in conjunction with the Versatrack Shim for 9.5mm-12.3mm* including 3/32nd underlayment.

Material: Cold Roll Steel

* For floors thicker than 12.3mm, please feel free to call one of our sales representatives for assistance.

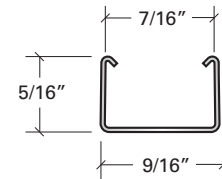
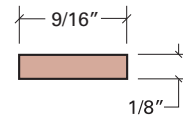
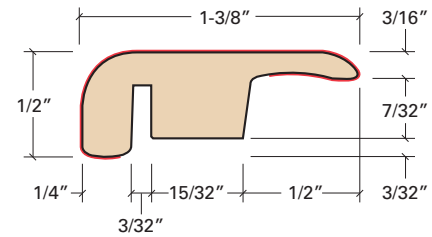

Installation

2.5 – 4.5 mm Floors

Use Gluedown for 2.5 - 4.5 mm floors.

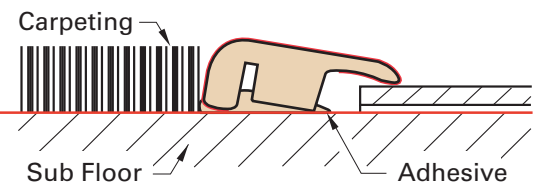

6 – 9 mm Floors

Use Versatrack (Metal Track) for 6 - 9.5 mm floors.

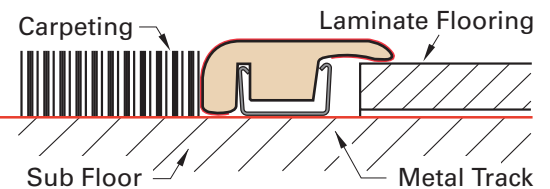

9.5 – 12.3 mm Floors

Use Versatrack & Versatrack Shim for 9.5 - 12.3 mm floors. Use the same molding & track, just add 1 Versatrack Shim.

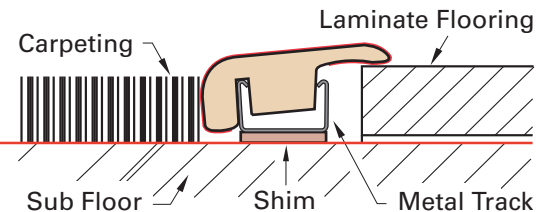

14 – 15 mm Floors

Use Versatrack & Versatrack Shim for 9.5 - 12.3 mm floors. Use the same molding & track, just add 2 Versatrack Shim.

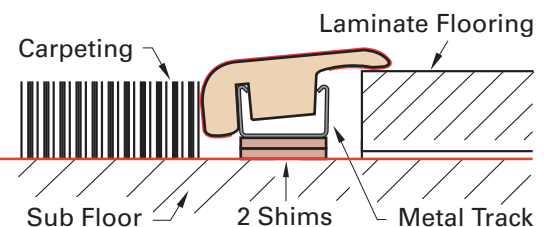

End Cap

Use Versatrack (Metal Track) for 6 - 9 mm floors.



6 - 9 mm Floors

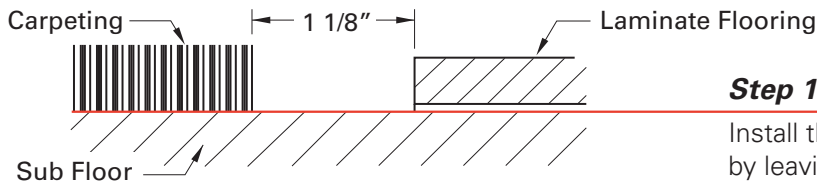

Step 1

Install the flooring planks including the underlayment by leaving a 1-1/8" inch (28mm) gap for the installation of the End Cap molding.

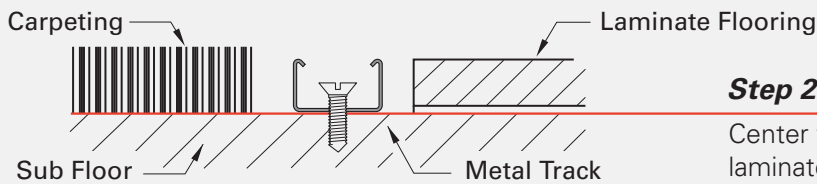

Step 2

Center the U-Track between the carpet and the laminate floor and screw it to the sub-floor by using #6x5/8" screws.

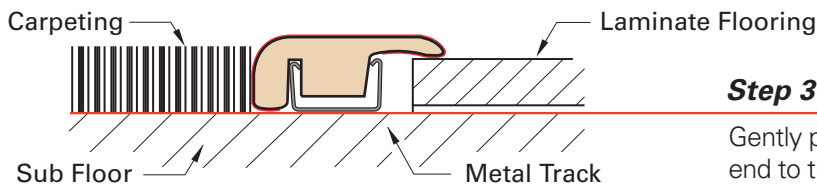

Step 3

Gently press the molding into the track starting from one end to the other just like you would close a Zip-Lock bag.

!!! Do not try to push the entire molding in all at once by just pressing it in from top !!!

Use Versatrack & Versatrack Shim for 9.5 - 12.3 mm floors.
Use the same molding & track, just add Versatrack Shim.

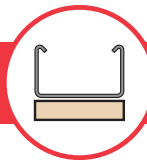

9.5 - 12.3 mm Floors

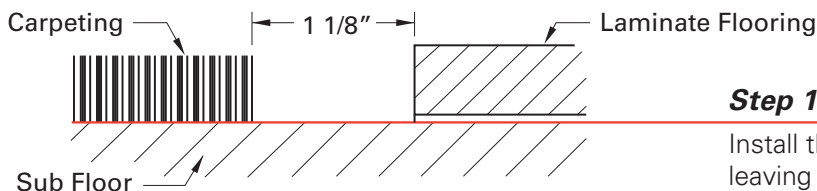

Step 1

Install the flooring planks including the underlayment by leaving a 1-1/8" inch (28mm) gap for the installation of the End Cap molding.

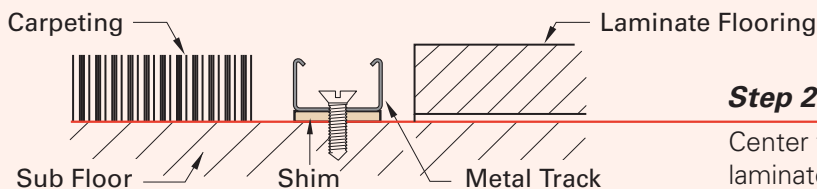

Step 2

Center the U-Track and shim between the carpet and the laminate floor and screw them to the sub-floor by using #6x5/8" screws.

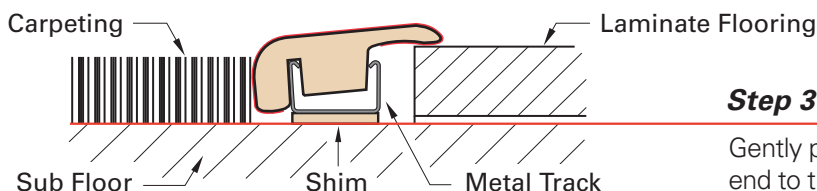

Step 3

Gently press the molding into the track starting from one end to the other just like you would close a Zip-Lock bag.

!!! Do not try to push the entire molding in all at once by just pressing it in from top !!!

End Cap

Use Versatrack & Versatrack Shim for 14 - 15 mm floors.
Use the same molding & track, just add Versatrack Shim.

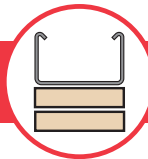

14 - 15 mm Floors

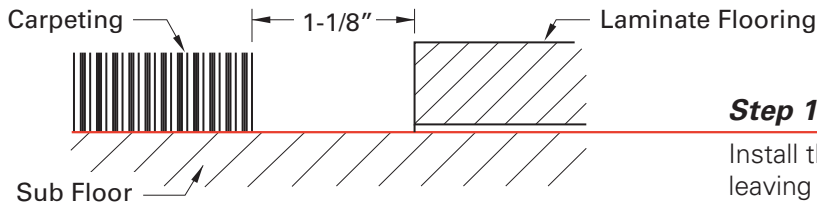

Step 1

Install the flooring planks including the underlayment by leaving a 1-1/8" inch (28mm) gap for the installation of the End Cap molding.

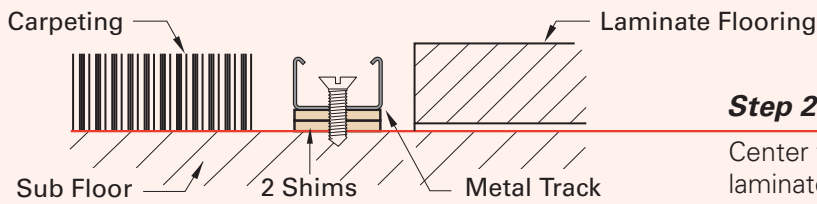

Step 2

Center the U-Track & the 2 shims between the carpet & the laminate floor and screw them to the sub-floor by using #6x5/8" screws.

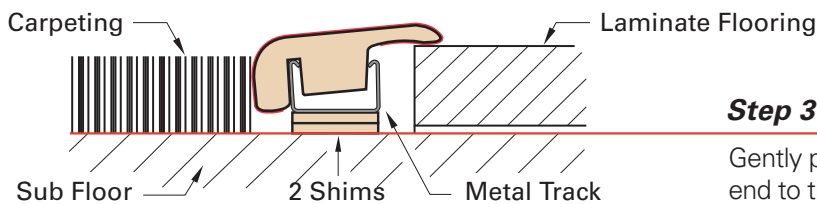

Step 3

Gently press the molding into the track starting from one end to the other just like you would close a Zip-Lock bag.

!!! Do not try to push the entire molding in all at once by just pressing it in from top !!!

End Cap - Glue Down on Subfloor or Concrete



Glue Down - 6-9 mm floors

6 - 9 mm Floors

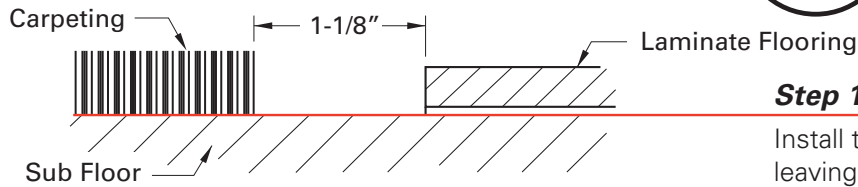

Step 1

Install the flooring planks including the underlayment by leaving a 1-1/8" inch (28mm) gap for the installation of the End Cap molding.

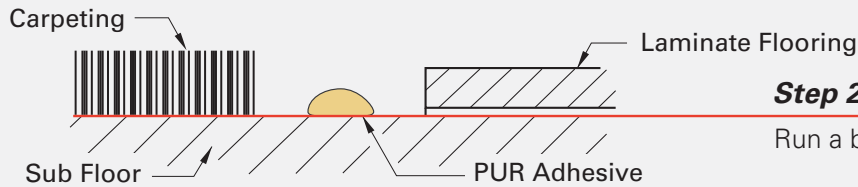

Step 2

Run a bead of PUR adhesive between the two planks

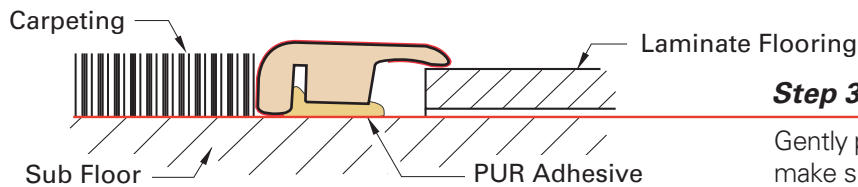

Step 3

Gently press the molding into the adhesive and adjust to make sure it is straight.



Glue Down with shim - 9-12.3 mm floors

9.5 - 12.3 mm Floors

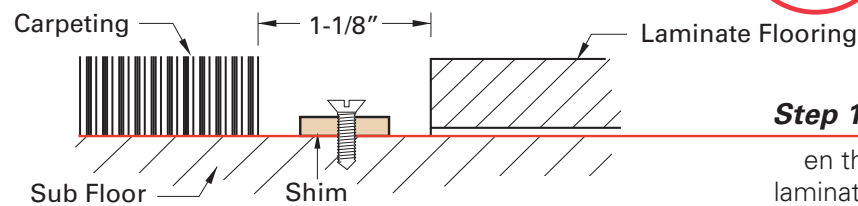

Step 1

Join the carpet and the laminate floor and screw them to the sub-floor by using #6x5/8" screws.

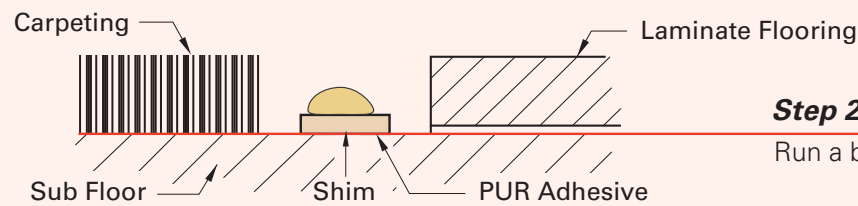

Step 2

Run a bead of PUR adhesive along the length of the shim.

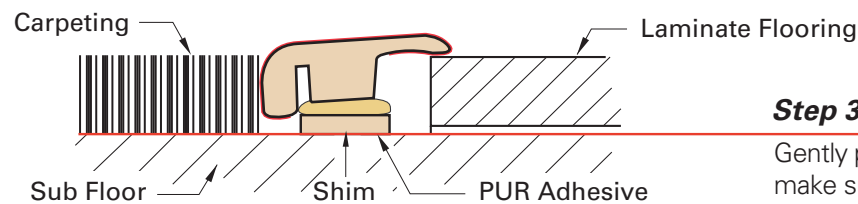

Step 3

Gently press the molding into the adhesive and adjust to make sure it is straight.

End Cap - CONCRETE Install

Use Versatrack (Metal Track) for 6 - 12.3 mm floors.

6 - 12.3 mm Floors

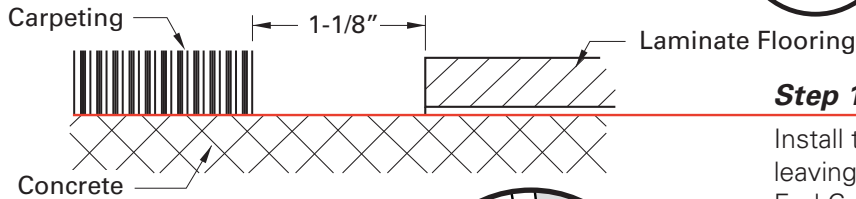

Step 1

Install the flooring planks including the underlayment by leaving a 1-1/8" inch (28mm) gap for the installation of the End Cap molding.

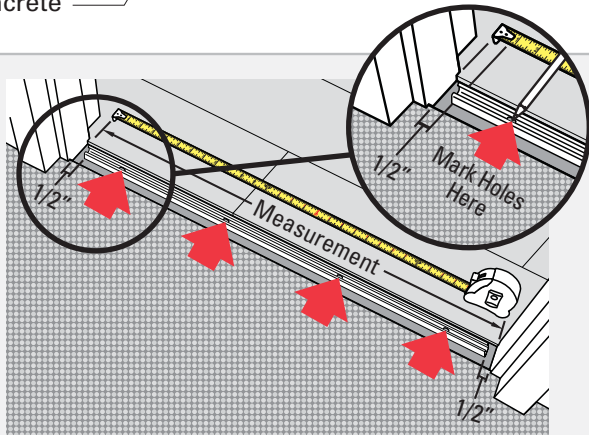

Step 2

Measure the door frame to determine width. Cut the Versatrack to the appropriate size of the door opening, leave a 1/2" gap on each side. Lay the Versatrack in the position to be installed, and mark each of the holes with a marker/pencil on the concrete floor. Make sure that the track does not shift while marking each hole.

General Disclaimer: Never drill into a slab that has radiant heating installed. Be aware of potential gas, electrical, water or low voltage lines present in the slab before starting your project. If unsure about these circumstances, we strongly recommend to use a glue down installation instead (See Page 4). The glue down option would require a high quality construction adhesive.

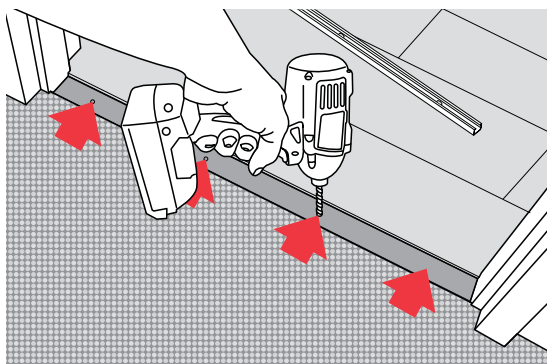

Step 3

Lay the track aside, and drill into the concrete floor by means of a 1/4" masonry drill bit. Make sure the drill does not 'dance' off the mark when starting to drill, as it will otherwise bend the track when affixing to the floor. Drill only as deep as your selection of dowel/screw combo requires. Never drill deeper than 1-1/2" into the concrete!

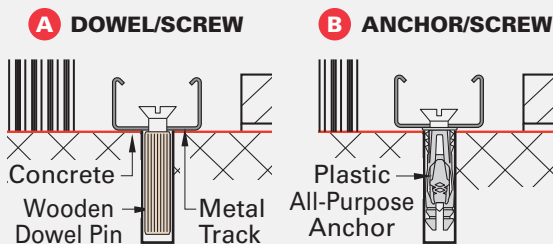

Step 2 - Use your preferred method of screw dowel combo:

A - Screw + 0.375 x 1.25" Wooden Dowel Pin: With #6 x 1" screws, this option will give you a little bit more flexibility in case the drill holes are not 100% in line with the trackholes. Make sure you drive the wooden dowel flush with the concrete, if it sits a bit high, scrape it flush with a chisel!

B - Screw + Plastic All-Purpose Anchor: Start all screws in each hole before you tighten one all the way down. This will ensure that all holes line up properly with the track.

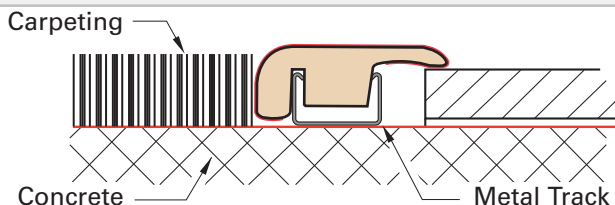

Step 3

Gently press the molding into the track starting from one end to the other just like you would close a Zip-Lock bag.

!!! Do not try to push the entire molding in all at once by just pressing it in from top !!!